

Extra Practice on Angles and Triangles - Tricky Ones!

© 2018 Kuta Software LLC. All rights reserved.

Find the value of x .

1)

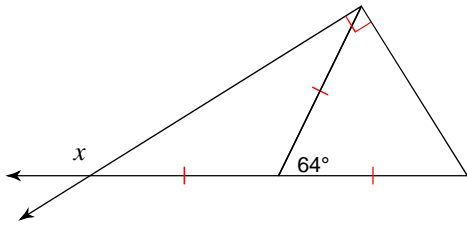

2)

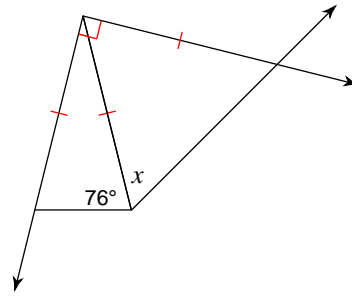

3)

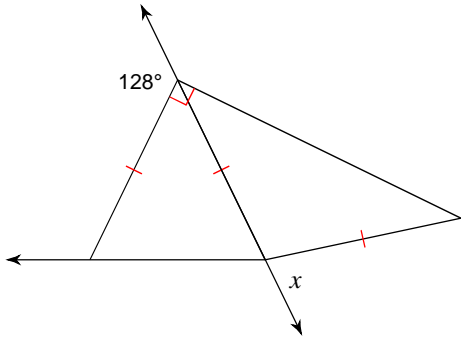

4)

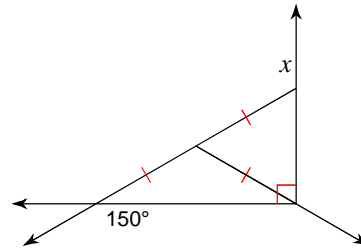

5)

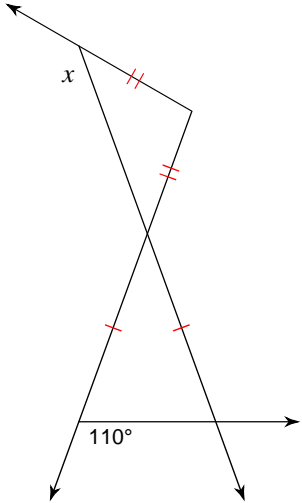

6)

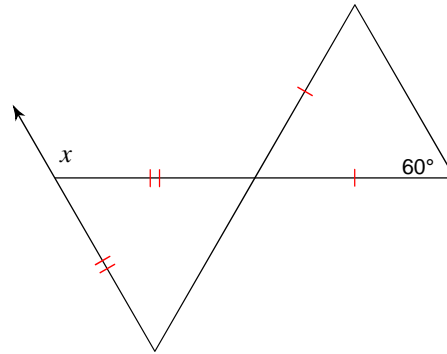

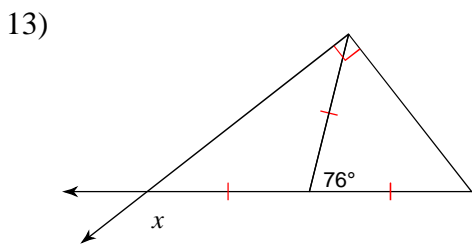
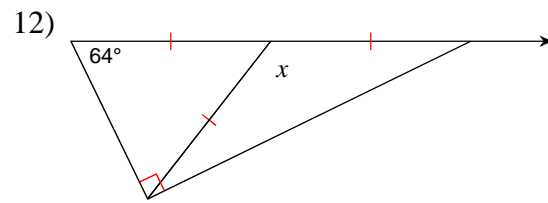
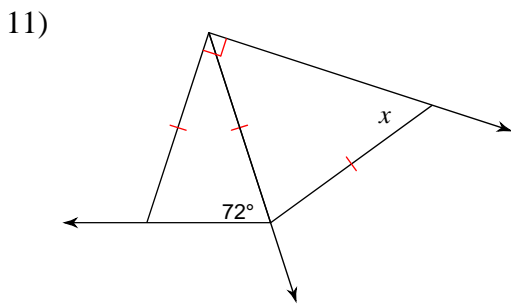
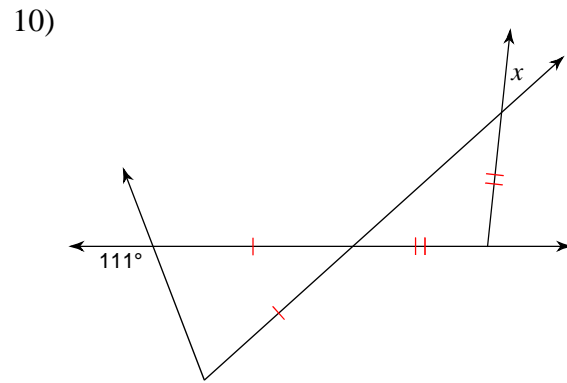
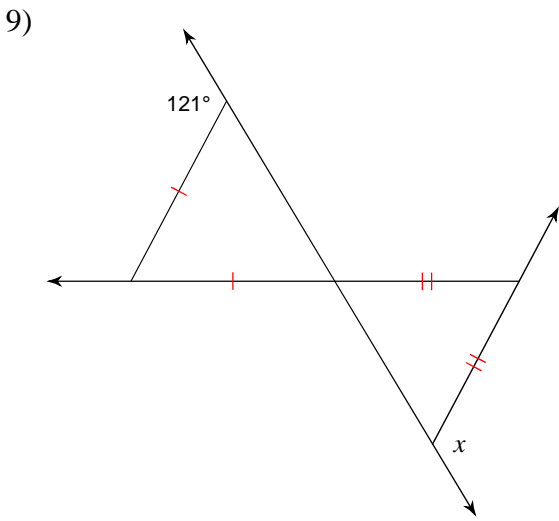
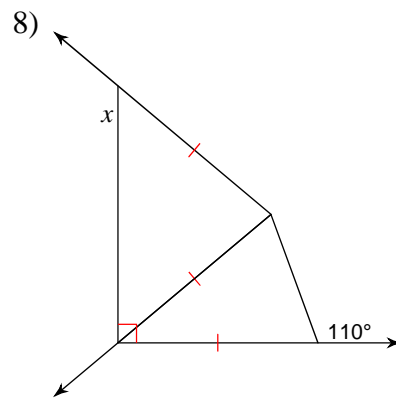
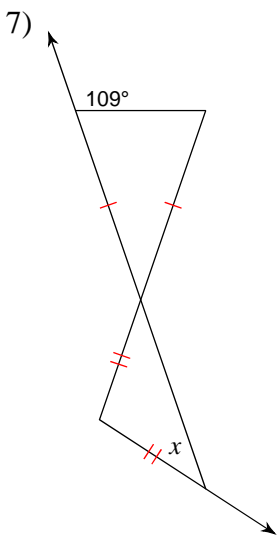

14)

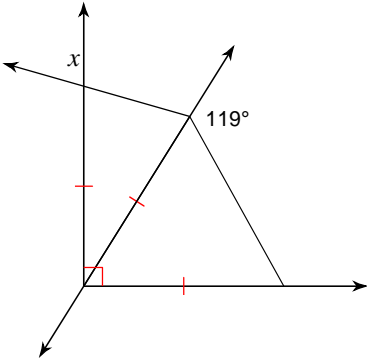

15)

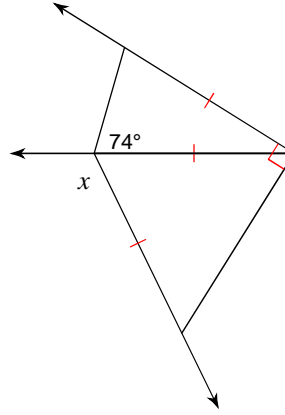

16)

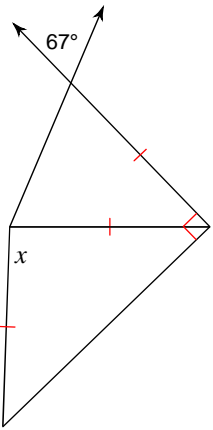

17)

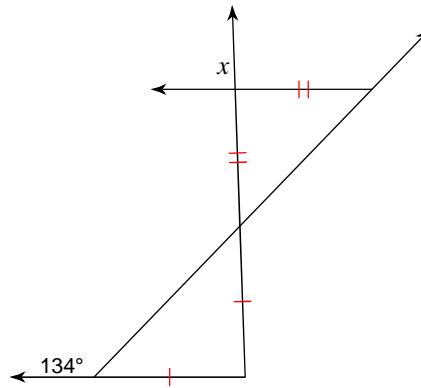

18)

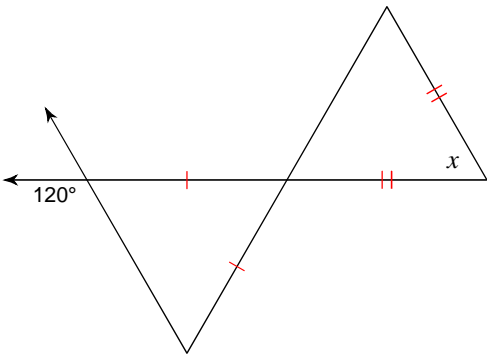

19)

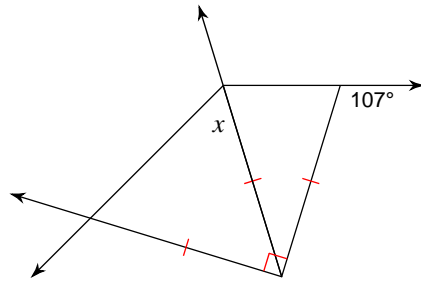

20)

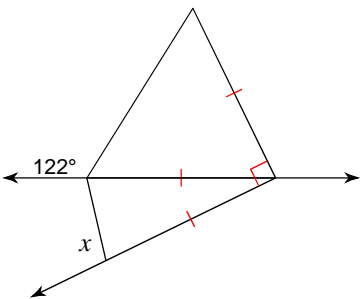

Find the measure of each angle indicated.

21)

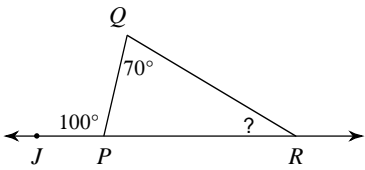

22)

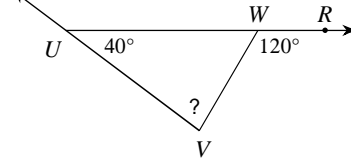

23)

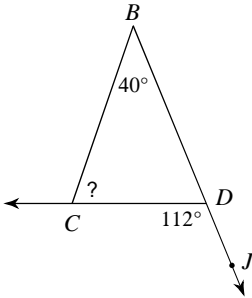

24)

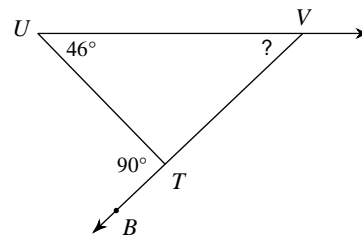

25)

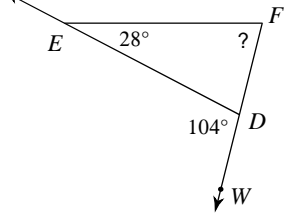

26)

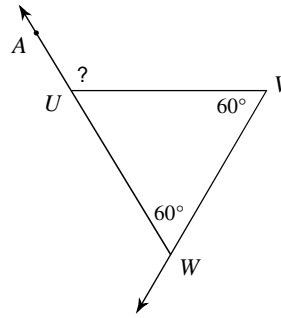

27)

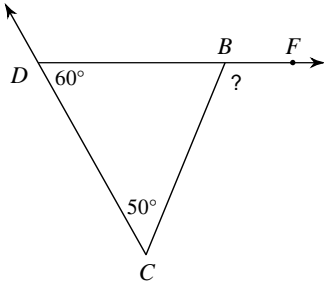

28)

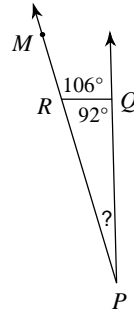

29)

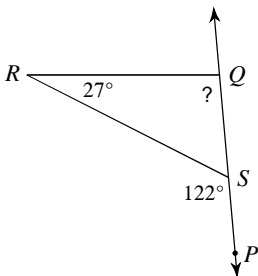

30)

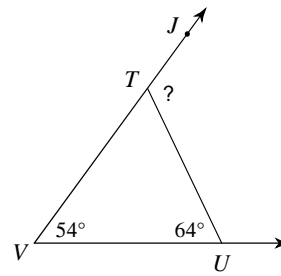

Solve for x .

31)

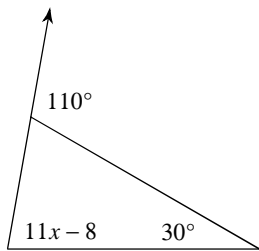

32)

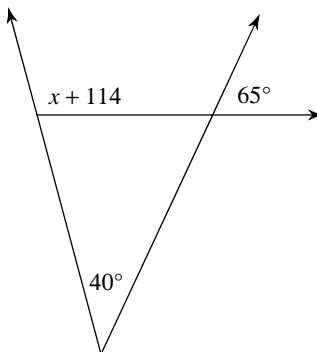

33)

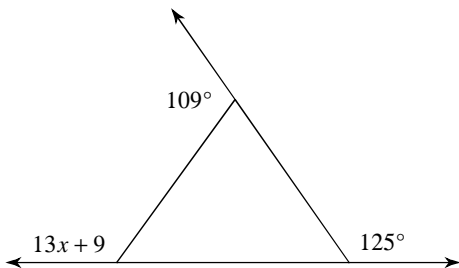

34)

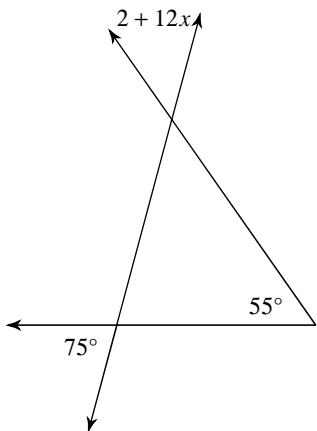

35)

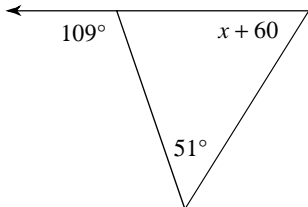

36)

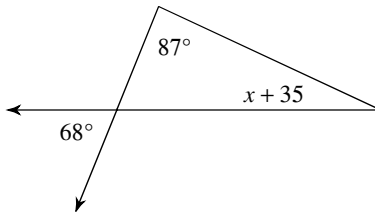

37)

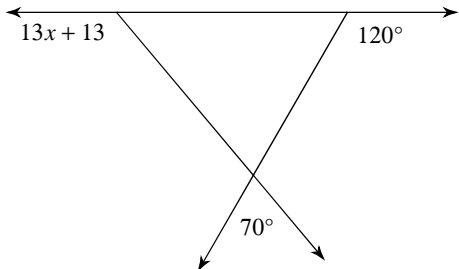

38)

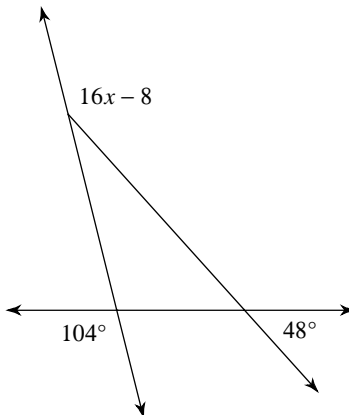

39)

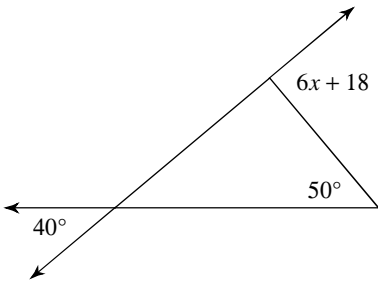

40)

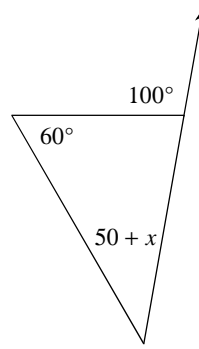

41)

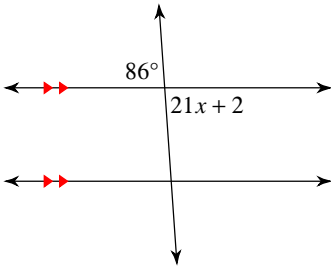

42)

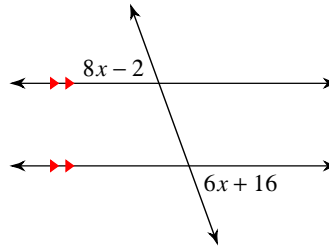

43)

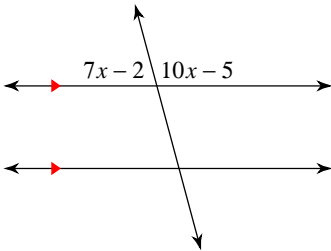

44)

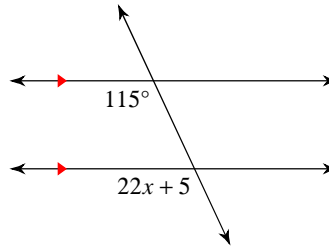

45)

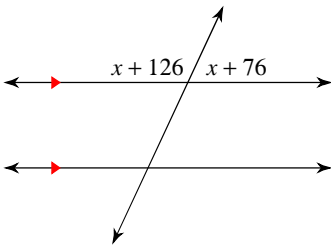

46)

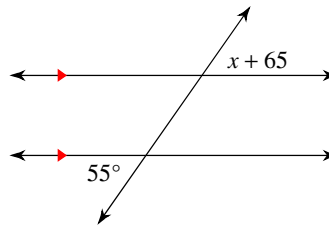

47)

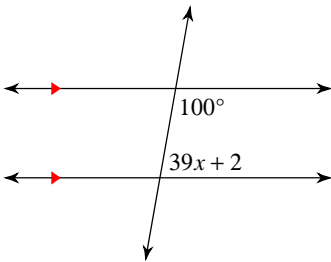

48)

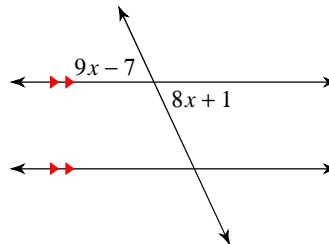

49)

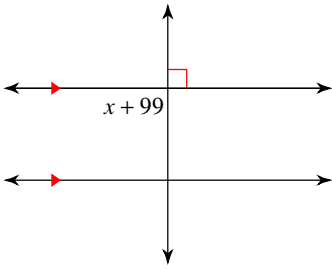

50)

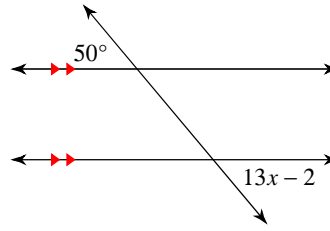

Answers to Extra Practice on Angles and Triangles - Tricky Ones! (ID: 1)

- | | | | |
|-----------------|-----------------|-----------------|-----------------|
| 1) 148° | 2) 59° | 3) 76° | 4) 120° |
| 5) 140° | 6) 120° | 7) 38° | 8) 130° |
| 9) 121° | 10) 42° | 11) 54° | 12) 128° |
| 13) 142° | 14) 74° | 15) 116° | 16) 92° |
| 17) 88° | 18) 60° | 19) 62° | 20) 103° |
| 21) 30° | 22) 80° | 23) 72° | 24) 44° |
| 25) 76° | 26) 120° | 27) 110° | 28) 14° |
| 29) 95° | 30) 118° | 31) 8 | 32) -9 |
| 33) 9 | 34) 4 | 35) -2 | 36) -10 |
| 37) 9 | 38) 10 | 39) 12 | 40) -10 |
| 41) 4 | 42) 9 | 43) 11 | 44) 5 |
| 45) -11 | 46) -10 | 47) 2 | 48) 8 |
| 49) -9 | 50) 4 | | |